

DECKING CLIP

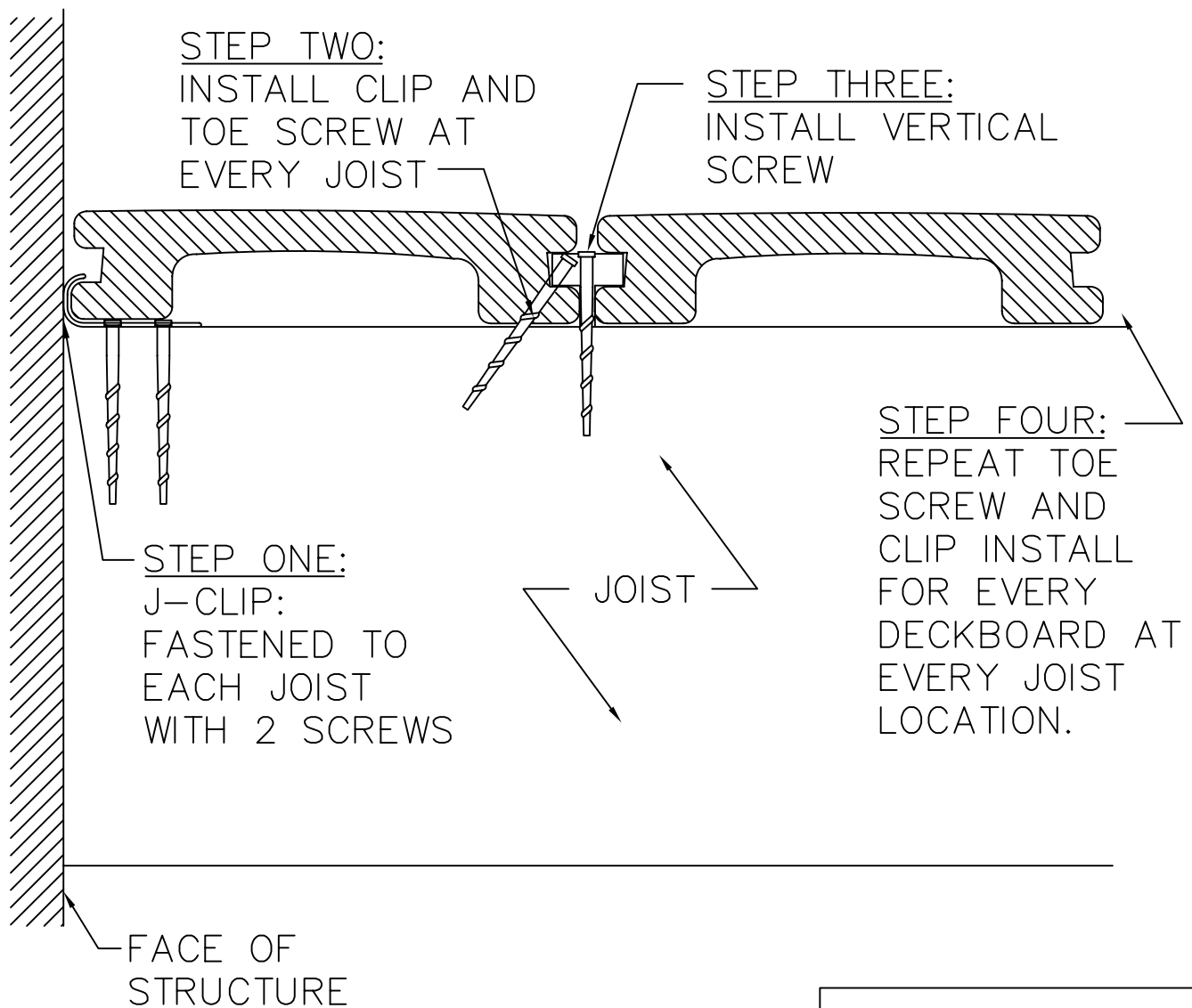

EVALUATED BY ICC
EVALUATION REPORT 97-63.1

TRIMAX DECKING INSTALLATION



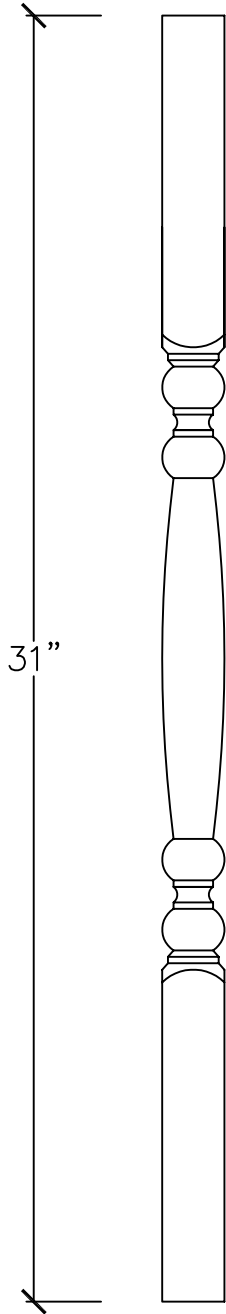

ITEM #2331
31" CUSTOM
TURNED SPINDLE
(WHITE ONLY)



ITEM #2231
31" CUSTOM
MILLED SPINDLE

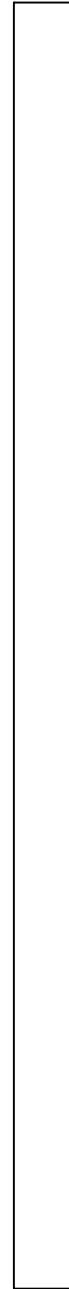

ITEM #1515
2X2 SPINDLE
STRAIGHT

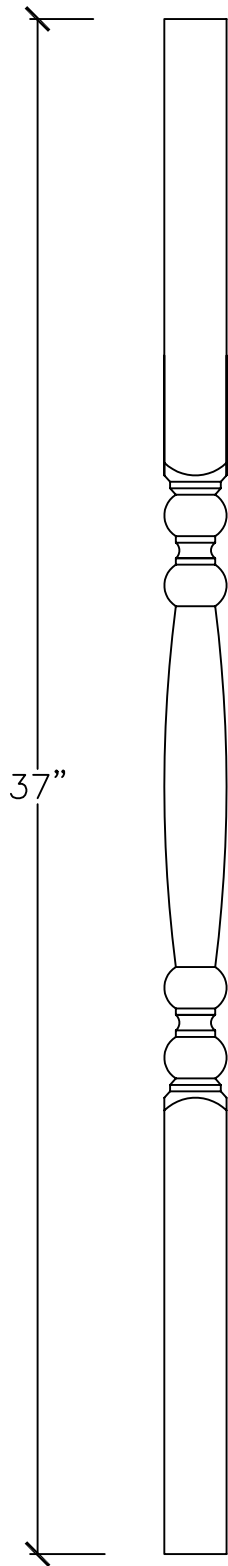

ITEM #2337
37" CUSTOM
TURNED SPINDLE
(WHITE ONLY)

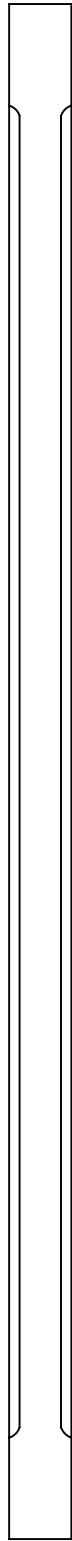

ITEM #2237
37" CUSTOM
MILLED SPINDLE

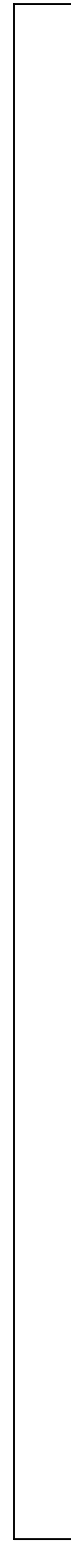

ITEM #1515
2X2 SPINDLE
STRAIGHT

37" SPINDLE OPTIONS



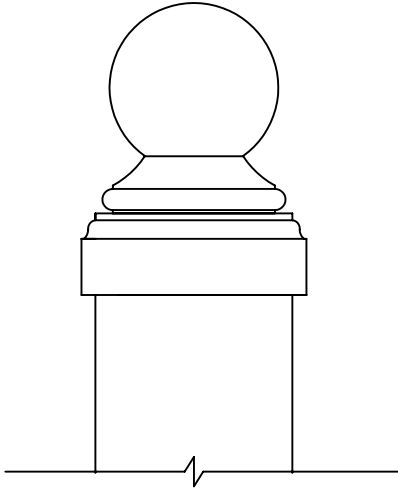

ITEM #2266
BALL TOP
ITEM #2245
CUSTOM POST
CAP

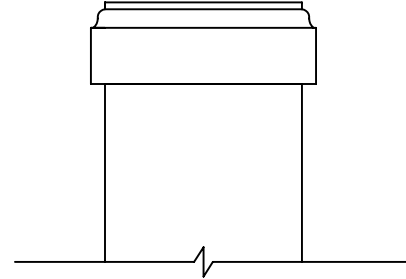

ITEM #2245
CUSTOM POST
CAP

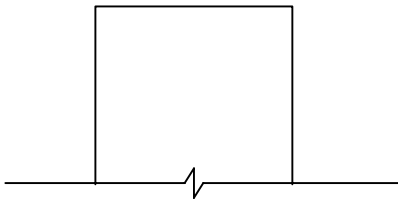

ITEM #3535
STANDARD 4X4

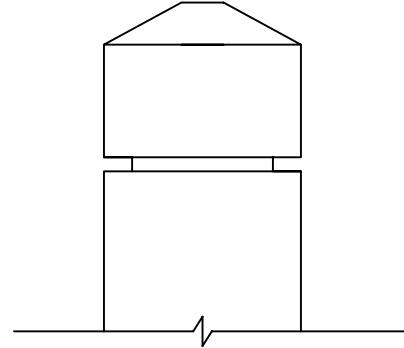

ITEM #4040
4" x 4" x 54"
PREFAB HDPE
POST WITH
PLATEAU TOP

STEP TWO:
DECK SCREW
FROM TOP OF
TRIM PIECE TO
SPINDLE

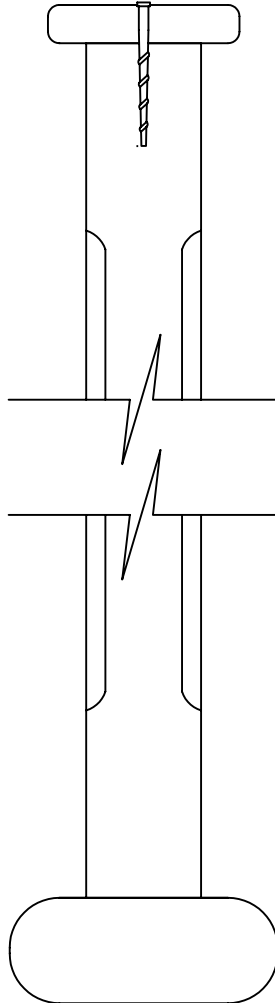

STEP THREE:
DECK SCREW
FROM BOTTOM
OF TRIM PIECE
UP THROUGH
TO TOP RAIL

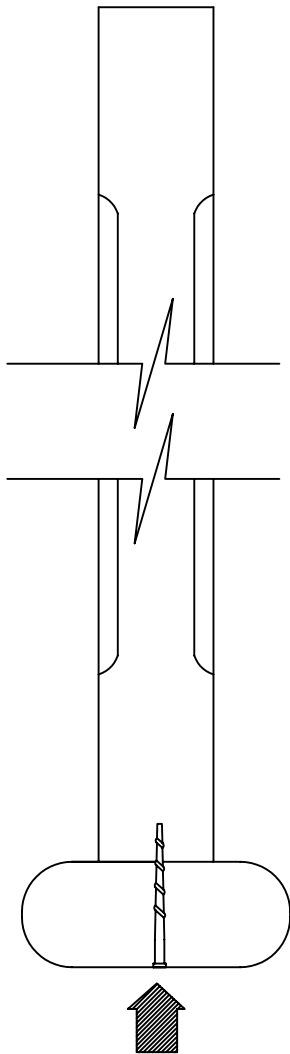
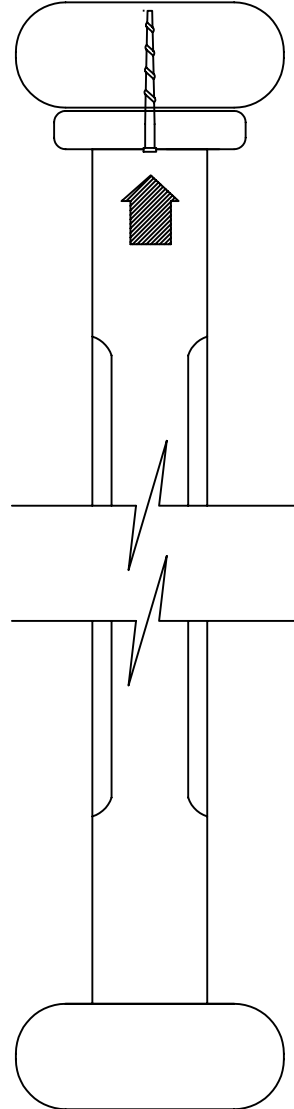

STEP ONE:
DECK SCREW
FROM BOTTOM
OF RAIL TO
SPINDLE

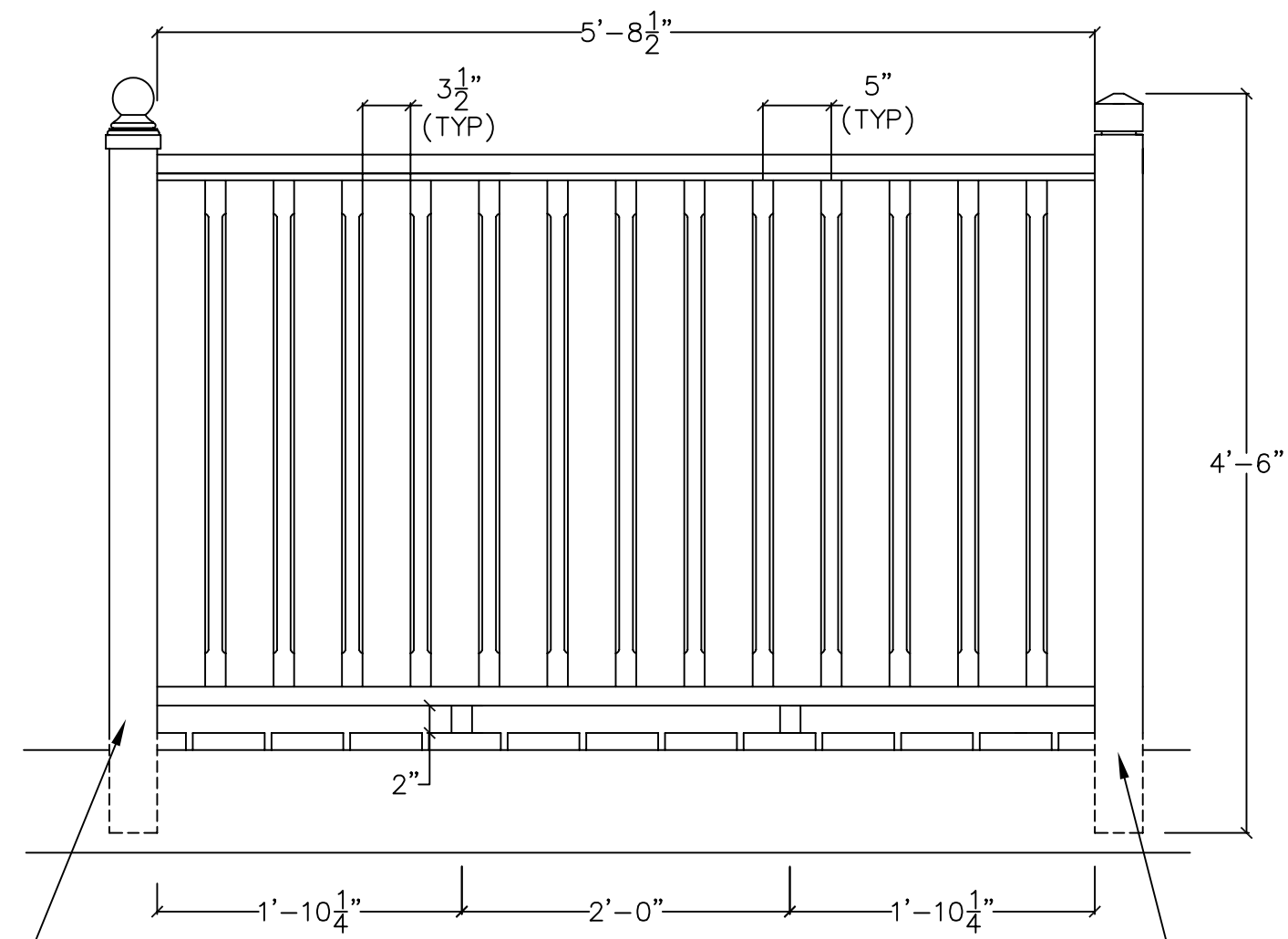

4"x4"x54" HDPE POST
WITH POST CAP AND
BALL CAP

4"x4"x54" HDPE POST
WITH PLATEAU TOP

6'-0" RAILING ASSEMBLY

APPROVED BY BOCA INTERNATIONAL
EVALUATION REPORT 97-63.1

RAILING ASSEMBLY



